

**ENTHUSIAST PRO**  
STRAIGHT RAZOR WITH INTERCHANGEABLE BLADE  
operating manual  
and safety instructions

## Content

- 1 About this document
- 2 Notes on safety
- 3 Potential hazards
- 4 Assembling the Straight Razor
- 5 Scope of delivery, transport, storage and installation
- 6 The correct use of MÜHLE products
- 7 Accessories and spare parts
- 8 Maintenance, cleaning and service
- 9 Returning the Straight Razor to MÜHLE
- 10 Disposal

### 1 About this document

It is imperative that you read this operating manual completely and carefully, including the safety instructions.

Improper use may cause serious injury. Always keep this operating manual to hand – do not throw it away!

It is absolutely imperative that you read this operating manual, including the safety instructions, completely and carefully. Improper use may cause serious injury.

Always keep this operating manual to hand – do not throw it away!

## **⚠ WARNING**

Please read these instructions before using this product and never let others use it without having read the manual. Please ensure that the manual is included if the Straight Razor is passed on or sold to other users. Failure to follow the instructions and safety precautions in this manual may result in serious injury. Keep this manual in a safe location for future reference.



**This manual applies to the following Straight Razors**

**ENTHUSIAST PRO**

Straight Razor with interchangeable blade,

Item Code RMW 6 and variants

For more information about selecting the right MÜHLE product for your needs, go to:

[www.muehle-shaving.com](http://www.muehle-shaving.com)

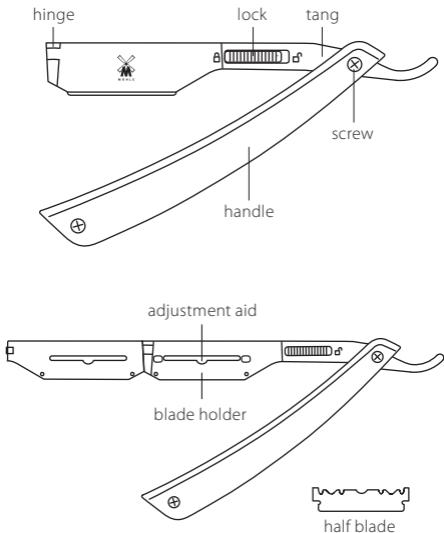

## 2 Notes on safety

### **⚠ WARNING**

**Failure to observe the safety instructions can result in serious injury.**

- > Always observe the safety instructions in this manual.
- > Read all instructions before using this razor.

MÜHLE Straight Razors are not intended for use by persons with impaired physical, sensory or mental abilities or lack of experience and knowledge, unless they have been supervised or have received instruction concerning the use of the Straight Razor and its accessories by a person responsible for their safety.

### 3 Potential hazards

Certain risks are associated with using a Straight Razor. Using a Straight Razor requires a high degree of concentration and caution. Use the Straight Razor only for its intended purpose (shaving the face and neck area).

Only use your MÜHLE Straight Razor after you have acquired extensive knowledge of the use of such razors. We recommend attending workshops conducted by professional users. To avoid bacterial infections, only use blades stored in packaging. To achieve the best results, the blades should be replaced after no more than five (5) shaves (or five (5) days). If the Straight Razor is used by or on different people, a separate blade should be used for each person for reasons of hygiene.

### 3.1 Cuts to the skin

Check the razor blade for damage or deformation before use. Your skin may otherwise be injured by the blade.

#### **⚠ CAUTION**

**Danger of skin laceration.  
Serious injuries and severe  
bleeding.**

- > Observe the razor blade for damages or deformation before use.
- > Read 4.1 (Guideline for changing the blade) and 6.1 (Usage hints) carefully.



### 3.2 Razor burn

If your skin appears abnormal after shaving, stop using the Straight Razor and consult a dermatologist. Continued use may worsen your skin condition.

#### **⚠ CAUTION**

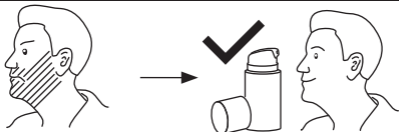

**Risk of skin rash.  
Serious reddening and burning skin.**

- > Use a sterile blade.
- > If skin reacts with irritation, apply a soothing after shave balm.

### 3.3 Skin irregularities and ingrown hairs

Do not apply strong pressure to the skin. Avoid sideways movements of the Straight Razor and excessive shaving of the same area of skin. Allow the Straight Razor to glide over your skin (only applying gentle pressure in line with the Straight Razor's net weight). Avoid areas of skin with spots, irregularities or pimples. Moreover, do not use the Straight Razor on sensitive or delicate skin or if you are prone to allergies. Its use may cause an allergic reaction or injure the skin.

#### **⚠ CAUTION**

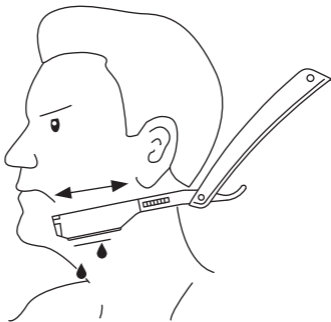

**Danger of wrong shaving performance.**

**Risk of allergies appearing.**

> Prevent using a jabbing motion and repeatedly moving over the same skin area.

## 4 Assembling the Straight Razor

Check the Straight Razor for functionality and damage.

Follow the instructions for inserting or changing the blade as described in section 4.1.

Only use blades stored in their original packaging.

### **⚠ WARNING**

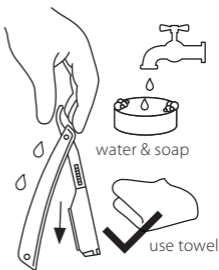





**BE VERY CAREFUL! Blades can cause serious injuries and severe bleeding.**

- > Use your thumb and index finger to grab the razor blade at its short, blunt sides.
- > Never touch the blades on its sharp edges!
- > Dry and clean your hands carefully before assembling the razor, handle and blade, and hold blades firmly to avoid dropping them.
- > Firmly attach razor head and handle to each other.

## 4.1 Guidelines for replacing blades

The MÜHLE ENTHUSIAST PRO Straight Razor (hereinafter referred to as "Straight Razor") is only compatible with half, traditional razor blades. For a close shave, use a blade only for a maximum of five (5) shaves. If the Straight Razor is used by or on different people, a new blade should be inserted before each use for reasons of hygiene. Insert the blade only with clean, dry hands. Follow the safety instructions for changing the blade:

1. Unfold the Straight Razor out of the handle so that the flap of the blade holder can be opened. Now lay the Straight Razor flat on a level surface so that the blade holder is horizontal. The hinge should point to the left and the tang to the right. The closed lock  and open lock  symbols should be visible.
2. With one hand, slide the grooved lock to the right towards the open lock  symbol in order to open the locking flap with the other hand. Open it by 180 degrees so that it lies flat.
3. Now insert the blade. Only touch the unsharpened ends of the blade on the sides. Insert the blade exactly with the help of the adjustment aids. Check again that the blade is fixed correctly.
4. Close the locking flap of the blade holder. Pull the lock slightly in the direction of the open lock  symbol and allow the lock to slide back into place after closing the flap. Check that the flap is closed correctly.
5. Check that the cutting edge of the blade runs parallel to the blade holder and that the blade is fixed correctly.



6. Make sure that the latch is firmly fixed to the side of the closed lock  and that it is held in place with sufficient spring tension.

7. Check that the handle is connected tightly enough to the blade mount or tang. A connection that is too loose may lead to an unsafe grasp of the blade in your hand and therefore to injuries.

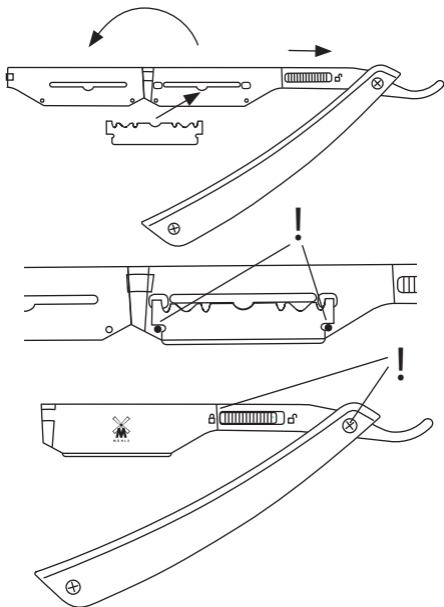

## 4.2 Storage

Make sure to store your Straight Razor in a safe and dry area, where it is out of reach for children and animals. Children are not able to handle a razor with the necessary care. This may cause serious accidents and injuries. Children and also animals could chew the razor, cut themselves or swallow down the blade.

### **⚠ DANGER**

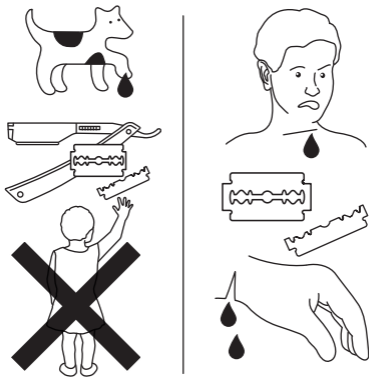

**Danger of little children not handling a razor with the necessary precaution.**

**Serious injury or death!**

- > Store razor blades in safe cartridges.
- > Keep the razor and especially the blades out of reach from children and animals.

## 5 Scope of delivery, transport, storage and installation

### 5.1 Unpacking/checking equipment and scope of delivery

After unpacking, please check the MÜHLE Straight Razor for any signs of damage. Do not use the Straight Razor if it shows any signs of damage. In this case, contact the vendor from which you purchased the product or our customer service.

### 5.2 Guidelines for safe transportation

Always ensure that your Straight Razor is safely packed when transporting it (e.g. in a case, box etc.). Remove the razor blade from the Straight Razor for transportation – transport both securely packed. Transporting a loose Straight Razor with inserted blade in a bag or toiletries bag may cause severe accidents and injuries.

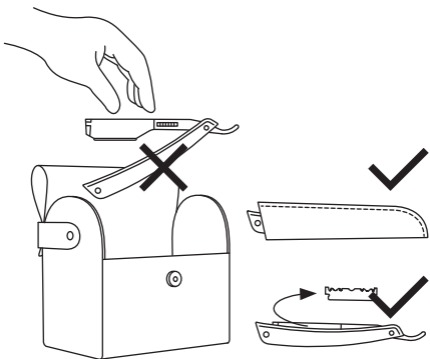

## 6 The correct use of MÜHLE products

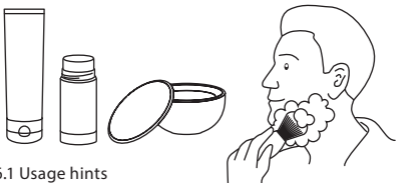

### 6.1 Usage hints

Only use your MÜHLE Straight Razor after you have acquired extensive knowledge of the use of such razors. Familiarise yourself with how to hold and guide the Straight Razor in your hand (see illustration on next page). Make sure your skin is clean. Moisten the beard area preferably with warm water and lather it thoroughly with a shaving brush. Make sure that the beard hair is well soaked. You should spend at least three minutes lathering up. Thoroughly soaking the beard hair reduces the risk of injury and is good for your skin. Always use a high-quality shaving cream or soap. This will help the blade glide more easily over the skin.

We recommend the MÜHLE SHAVECARE line for a sensual and refreshing wet shave.

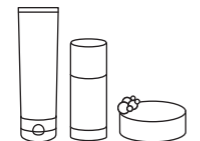



shaving cream & soap

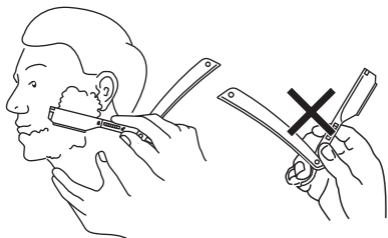
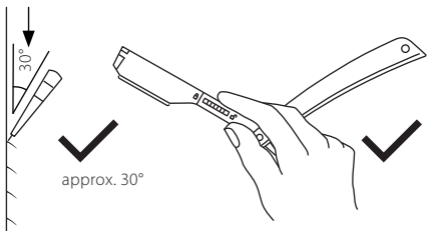

after shave & alum stone



Insert a new and unused blade (see 4.1). Check the correct positioning of the blade using the adjustment aids in the blade holder. Make sure that the grooved lock is to the side of the closed lock  symbol after inserting the blade and that the flap of the blade holder is properly closed. Check that the slider is held in place to the side of the closed lock  symbol with sufficient spring tension and that the blade is inserted parallel to the blade holder. If any of the abovementioned criteria are not met or you have doubts about the proper functionality of the Straight Razor, do not use this product.

If you establish that the blade is not firmly fixed in the holder, do not continue shaving. Hold the blade of the Straight Razor at a sharp angle (approx. 30°) to the skin. Start with the cheeks and allow the Straight Razor to glide over the skin, applying gentle pressure. Always start to shave in the direction of the hair growth (with the grain). Pull the skin area to be shaved tight with your free hand. Never shave dry skin! Shave only once over the face/neck area at first. If the skin is irritated, do not continue shaving. Please note that different blades may have varying levels of sharpness. See 3 – 3.3 to find out more about potential hazards.

## 6.2 Problem: poor shaving performance

If the shaving performance is unsatisfactory or injuries occur, this may be due to the following reasons:

**The Straight Razor may be damaged or the blade is slightly rusty or worn:** stop using the MÜHLE Straight Razor. Check the razor for functionality and signs of wear. Insert a new blade. Continued use with rusty blades may cause inflammations.

**The blade is not properly inserted in the Straight Razor:** check that the blade is securely fixed. Make sure that the grooved lock is to the side of the closed lock  and that the lock can only be opened with resistance. Make sure that the flap of the blade holder can be closed tightly and that the hinge has minimal slack. Check that the razor blade is fixed correctly using the adjustment aids.

Check that the cutting edge of the blade is parallel to the blade holder.

**Hair is stuck in the blade gap:** open the lock of the Straight Razor and carefully remove the blade. Now clean the Straight Razor under running water. If necessary, use a brush to remove hair, stubble or other dirt. If the beard hair to be shaved is too long and thick, it should be trimmed with a beard trimmer before shaving.

**The Straight Razor is dirty, the lock no longer closes properly or is difficult to open:** the MÜHLE Straight Razor has not been cleaned sufficiently or has not been cleaned for a long time. Clean the Straight Razor thoroughly before you start shaving. Make sure that the locking flap is easy to open and close and has minimal slack. Remove any soap, foam or stubble residue from the lock. Check that the lock closes with sufficient spring tension and that it is held in place to the side of the closed lock  symbol.

## 7 Accessories and spare parts

MÜHLE is only responsible for the safety features of the appliance provided.

Only qualified personnel are authorised by MÜHLE to perform all maintenance, repairs and replacement in case of a defect using original spare parts. The user is responsible for any risk arising from the use of unauthorised accessories.

Matching razor blades are available as replacements.



### NOTICE



damaged  
blade holder  
or lock

#### **Risk of reduced shaving performance and destruction of the Straight Razor!**

- > Handle the lock and hinge of the Straight Razor with care.
- > Do not exert excessive force on parts of the Straight Razor as parts may deform or bend.
- > Avoid dropping the Straight Razor.

### 8.1 Maintenance and service

Never modify, disassemble or repair the MÜHLE Straight Razor by yourself. This may cause unexpected injuries or destruction of the appliance. Contact the vendor from which you purchased the MÜHLE Straight Razor or our customer service department for repair.

The use of different brands of blades may alter the performance of the Straight Razor and worsen shaving results. Some blades may lose their sharpness after a short time. Dropping, bending or exerting excessive force may damage the Straight Razor or its handle.



## 8.2 Cleaning and disinfection

Make sure to remove the blade from the Straight Razor before cleaning it! Regular cleaning ensures improved performance of the appliance. Rinse the Straight Razor under running tap water after each shave or use a mild detergent for quick and easy cleaning. Do not under any circumstances use petrol, thinner, acid or vinegar for cleaning! This may lead to malfunctions, cracks or discolouration of the parts. Dry off excess water with a towel and allow the Straight Razor to dry. To avoid bacterial infections, only use blades stored in their original packaging. For reasons of hygiene and to achieve optimal results, the same blade should only be used for five shaves.

### **⚠ WARNING**



**Danger of cuts and bacterial infections.  
Injuries, severe bleeding on hands and malfunction  
of the razor.**

- > Do always remove the razor from the blade during cleaning the equipment.
- > Under no circumstance use petrol, thinner, acid or vinegar to clean the razor!

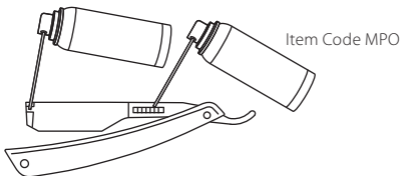

Oil the hinge and lock of the Straight Razor with MÜHLE Maintenance Oil (Item Code MPO) to ensure the smooth operation of these components. MÜHLE Maintenance Oil was specially developed to this end.

## **NOTICE**

**Never attempt to disassemble the Straight Razor!**

### **9 Returning the Straight Razor to MÜHLE**

If you return the product to MÜHLE or to your vendor, please make sure to specify the following information:

- MÜHLE product type and serial number (or serial number used by your distributor)
- Include a copy of the sales receipt
- Name and address of the distributor from which you bought the MÜHLE product
- Exact description of malfunction, defect or damage which was caused by a defect
- Your full address and possibility to get in contact with you (phone number, eMail address)

## 10 Disposal

If recycling is an available option, please dispose the different packaging materials (paper, metal etc.) for recycling. Please observe the local regulations when doing so. Used blades should be safely disposed in suitable cartridges or protective paper. Throwing away a blade without protective covering may cause serious injuries.

### **⚠ WARNING**

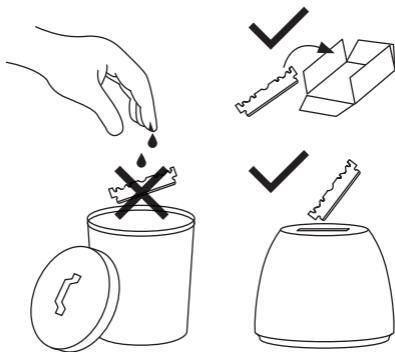

Blade Bank  
Item Code BB

**Danger of cutting.**

**Serious cutting injuries with severe bleeding.**

> Put the used blade in a protective cover (cartridge) before disposing it in the garbage.

## Supplier

Hans-Jürgen Müller GmbH & Co. KG  
(referred to as "MÜHLE")

## Address

Hauptstraße 18  
08328 Stützensgrün (Germany)

## Product

MÜHLE Straight Razor with interchangeable blade

## Typ

ENTHUSIAST PRO  
Item Code RMW 6 and variants



#rasurkultur

## Translation?

[tutorial.muehle-shaving.com](http://tutorial.muehle-shaving.com)



Hans-Jürgen Müller GmbH & Co. KG

Hauptstraße 18

08328 Stützensgrün (Germany)

+49 (0)37462-652-0

[info@muehle-shaving.com](mailto:info@muehle-shaving.com)

[www.muehle-shaving.com](http://www.muehle-shaving.com)